









Congratulations, you have purchased the finest exhaust system for your motorcycle on the market. Your Vance & Hines exhaust system is designed and crafted for maximum performance, a perfect fit, a great sound and unbeatable style. Please follow the installation instructions below and if you have any questions, please call our technical support line at (562) 926-5291.

Attention installer (if other than owner), please forward this instruction sheet to the owner of this product. These instructions contain valuable information to the end user.

**TOOLS
REQUIRED**

-  Flat blade screwdriver
-  Snapping pliers
-  5/16" Nutdriver
-  Ratchet 3/8" drive
-  Wrenches 9/16" 1/2", and 7/16"
-  9" Extension sockets 9/16", 3/4" & 1/2"
-  3/16" & 5/16" Allen wrench

READ ALL INSTRUCTIONS BEFORE BEGINNING INSTALLATION

**STOCK EXHAUST
SYSTEM REMOVAL**

1. Loosen the heat shield clamps on both the front and rear exhaust pipes. This allows easier access to the head pipe mounting nuts.
2. Remove the two head pipe mounting nuts from each flange, located at the cylinder head.
3. Remove nut and bolt holding rear header/muffler to mounting bar, and slide off.
4. Remove the nut which mounts the front muffler body to the belt drive cover and remove front exhaust pipe. Note: Nut will be re-used for reinstallation.
5. Remove two bolts that attach mounting bar to frame and remove.
6. Remove brake line clip mounting bolt. Note: Put aside for reinstallation.
7. Take note/ photos during brake pedal disassembly to ease reinstallation.
8. Remove cotter pin and pivot shaft from brake pedal (Figure 7).
9. Remove two socket head cap screws holding brake master cylinder to belt drive cover. Put aside for reinstallation.
10. Remove right rider foot peg.
11. Remove three allen head cap screws holding belt drive cover on and remove cover.
12. Remove cotter pin and backing nut on backside of belt drive cover.
13. Disassemble pedal assembly and put aside for reinstallation
14. Remove rear passenger foot peg and peg mount. Put aside for reinstallation.
15. Using snapping pliers, carefully remove the flanges and circlips from the stock exhaust system. Save for re-use. Note: If circlips look bent or twisted replace them with new circlips.

FIGURE 1



FIGURE 2

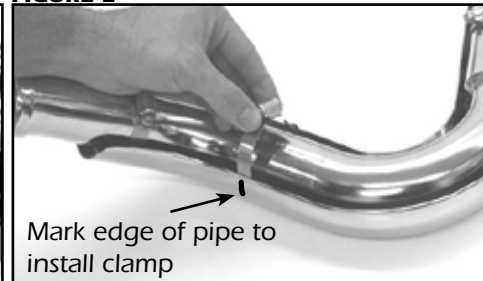

FIGURE 3

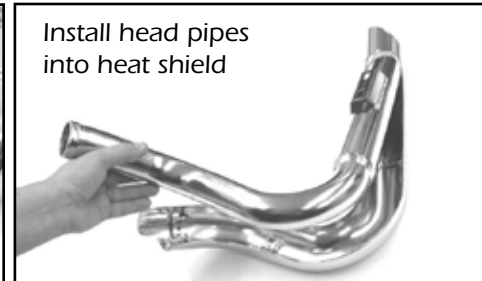

FIGURE 4



FIGURE 5

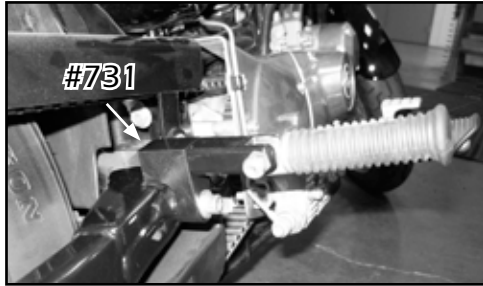

FIGURE 6

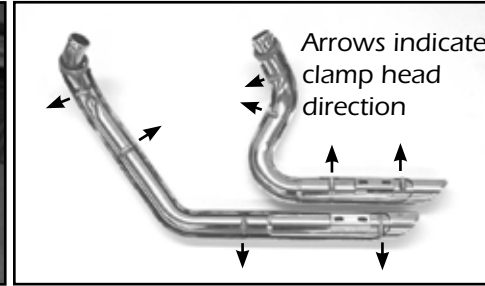

FIGURE 7

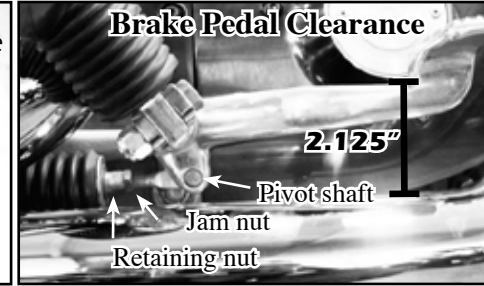
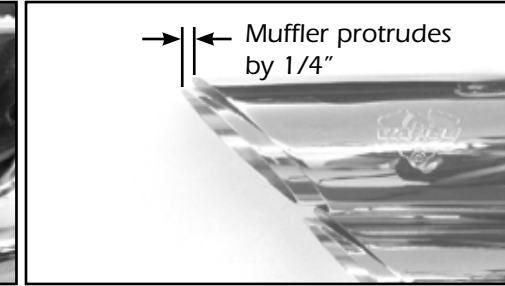

FIGURE 8



VANCE & HINES EXHAUST SYSTEM INSTALLATION

1. Check condition of stock exhaust gaskets. Replace if damaged or worn. Vance & Hines recommends you replace your gaskets with Screamin' Eagle gaskets part number 17048-98.
2. Install passenger peg relocating bracket (731) onto existing peg mount location on swing arm with supplied socket head bolt (A100HW) (Figure 5).
3. Bolt stock passenger peg and mount onto (731) bracket with stock hardware (Figure 5).
4. Reinstall brake pedal assembly in the reverse sequence of disassembly, but with new supplied brake foot pedal extension (A499HW) (Figure 4).
5. Slide brake pedal onto foot peg extension.
6. Slide assembly through brake master cylinder mount and belt drive cover.
7. Reinstall backing nut and install supplied larger cotter pin (A501HW).
8. Reinstall belt drive cover onto motorcycle with stock hardware and tighten.
9. Reinstall stock foot peg onto foot pedal extension with same rotation as stock (Figure 4).
10. Install brake master cylinder on to belt drive cover with two stock socket head cap screws. Sandwich brake master mount in between brake master and cover and tighten.
11. Reattach brake master cylinder and clevis onto brake pedal with stock pivot shaft and supplied smaller cotter pin (A156HW).
12. Reinstall brake line clip on belt drive cover using stock bolt.
13. Install and tighten supplied exhaust mounting bracket (729-P)(Figure 1) using two 3/8-16 x 2" socket cap screws, two washers, and two lock nuts. (supplied).
14. Remove header pipes and heat shields from protective packaging. Place each heat shield on a non-abrasive surface such as a blanket or carpet. Using a felt tip pen, mark outside edge of each heat shield to show location of mounting clips where hose clamps will loop through (Figure 2).
15. Lay head pipes into heat shields (Figure 3) and loosely install hose clamps by feeding tail end of clamp into heat shield clips. Take note of screw head

16. Install circlips and flanges from the stock system onto both new head pipes.
17. Using stock flange nuts, carefully install head pipes into exhaust ports (Assistance may be required). Note: Do not tighten at this time.
18. Slide nutplates inside brackets welded to backside of muffler bodies. While holding nut plates in place, attach muffler bodies to mounting bracket 729-P using four 5/16"x 5/8" flange head bolts (supplied). Leave them loose at this time.
19. Tighten cylinder port exhaust flange nuts on front and rear cylinders while making sure pipes are parallel.
20. Tighten the bracket flange bolts on both mufflers.
21. Tighten all heat shield clamps. Note: Muffler bodies should protrude from heat shields by 1/4" (Figure 8).
22. Check for adequate clearance between all exhaust system components and motorcycle accessories prone to heat damage.
23. **WARNING: Adjust brake pedal at clevis by loosening jam nut and turning clevis retaining nut to achieve proper minimum clearance of 2.125" from top of front heat shield (D115HC) to top of radius on brake pedal. (Figure 7)**
24. **Be sure to tighten all hardware before starting motorcycle.**

EXHAUST CARE - HELPFUL HINTS TO AVOID DISCOLORATION OF EXHAUST SYSTEM

1. When installing a new set of chrome pipes, make sure your hands are clean and free of oil. After installation, thoroughly clean pipes with a soft cloth and cleaning solvent that will leave no residue (chrome wax / polish, glass cleaner, alcohol, ammonia, etc...) before starting the motorcycle.
2. Follow owners manual instructions regarding use of the choke (starter enricher). If left on longer than recommended, discoloration may be accelerated.
3. Avoid long periods of idling as this can cause discoloration.
4. Intake leaks can cause the engine to run lean and overheat, this could lead to discoloration.
5. Make sure there are no exhaust leaks at the junction of the exhaust pipes and cylinder head. We recommend replacing gaskets if they are worn.

VANCE & HINES OPTIONAL ACCESSORIES

QUIET BAFFLE

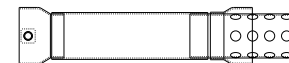

Quiet baffle P/N 21301 is available for this system. The quiet baffle will lower the sound level by 2-3db on average. Contact your local dealer to order.

PLEASE NOTE:
Every effort is made for Vance & Hines Exhaust Systems to provide improved cornering clearance. However, due to design and space limitations on some motorcycle models, ground and cornering clearance may not be improved and in some cases may be reduced. Be sure to follow proper installation instructions.



PACKING LIST

ALL PARTS SHOWN ARE ACTUAL SIZE

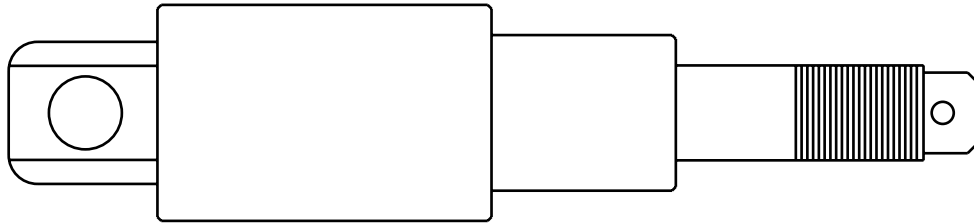

Foot Peg Extension x1

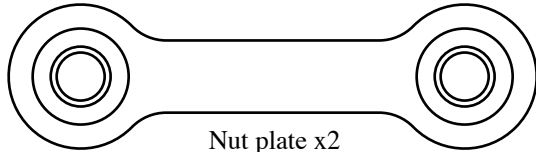

Nut plate x2

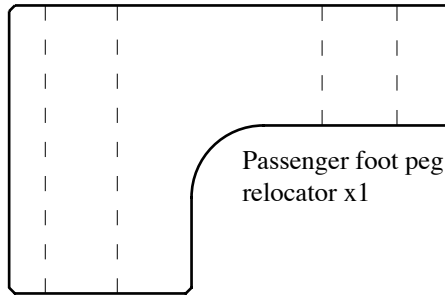

Passenger foot peg
relocater x1

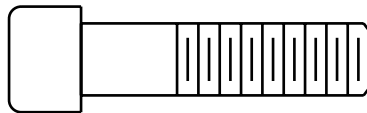

3/8-16 x 1 1/2 Cap Screw x1

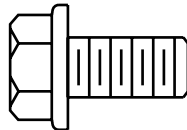

5/16-18 x 5/8 Flange
bolt x4



3/8-16 x 2 Cap Screw x2



Cotter pin x1



Cotter pin x1

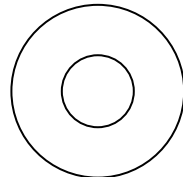

3/8 Flat washer x3

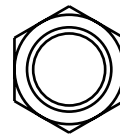

3/8-16 Lock nut x2

#28 Hose clamps x3

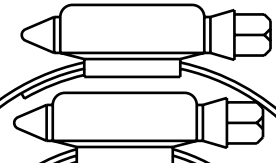

#20 Hose clamps x5

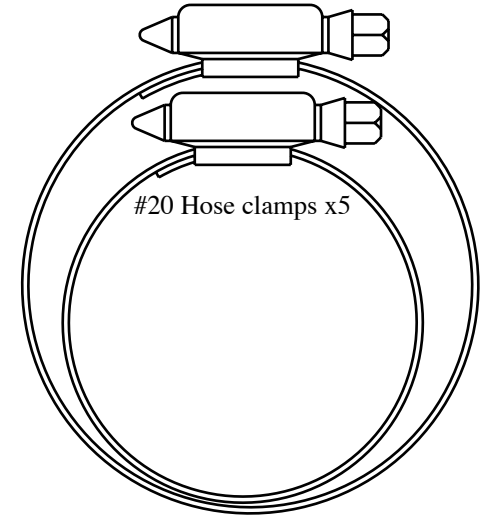

PARTS NOT SHOWN:

- 729-P Bracket x 1
- D115FC Front head pipe x 1
- D116FC Rear head pipe x 1
- D115HC Front heat shield x 1
- D116HC Rear heat shield x 1

WARRANTY

Vance & Hines exhaust systems are warranted against defects in material and workmanship for a period of 90 days from the date of purchase from an authorized dealer. This warranty does not cover discoloration of chrome finishes. This warranty is limited to the repair or replacement of a product proven to be defective from normal use. Vance & Hines exhaust systems are designed to fit and operate on OEM motor and chassis. This warranty does not cover any product subject to abuse, misuse, improper installation or modification.

FUELPAK

GET THE MOST OUT OF YOUR RIDING EXPERIENCE...

AN AFTERMARKET EXHAUST SYSTEM IS ONLY YOUR FIRST STEP, NOW YOU NEED FUEL MANAGEMENT.

YOU NEED FUELPAK.

Fuel injected Harley-Davidsons® are equipped with an ECU (electronic control unit) that's programmed to deliver fuel to the motor based on an air/fuel ratio for a stock air filter and stock exhaust system. When you install a performance exhaust system, your airflow changes, so you need a fuel management system that adjusts your air/fuel ratio to match the changes. That fuel management system is Fuelpak. Fuelpak adds and takes away fuel, allowing for a more precise range of refinement in your air/fuel ratio. Get the perfect fuel management combination with your Vance & Hines exhaust system, get Fuelpak. For more information visit the tuning center at vanceandhines.com/fuelpak.



13861 ROSECRANS AVENUE / SANTA FE SPRINGS, CA 90670
SALES: (562) 921-7461 / TECHNICAL: (562) 926-5291 / FAX: (562) 802-0110
VANCEANDHINES.COM