



INSTALLATION GUIDE

PART: 1310-1739

LEGEND REVO-A

WWW.LEGENDSUSPENSIONS.COM

FITMENT:

2015-18 INDIAN SCOUT,
2016-18 SCOUT SIXTY,
2018 SCOUT BOBBER MODELS

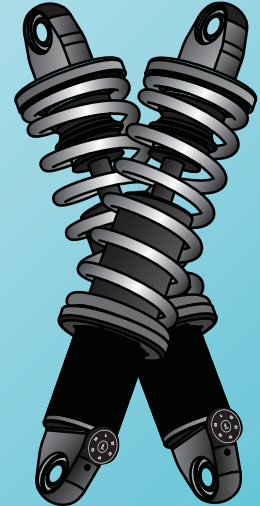
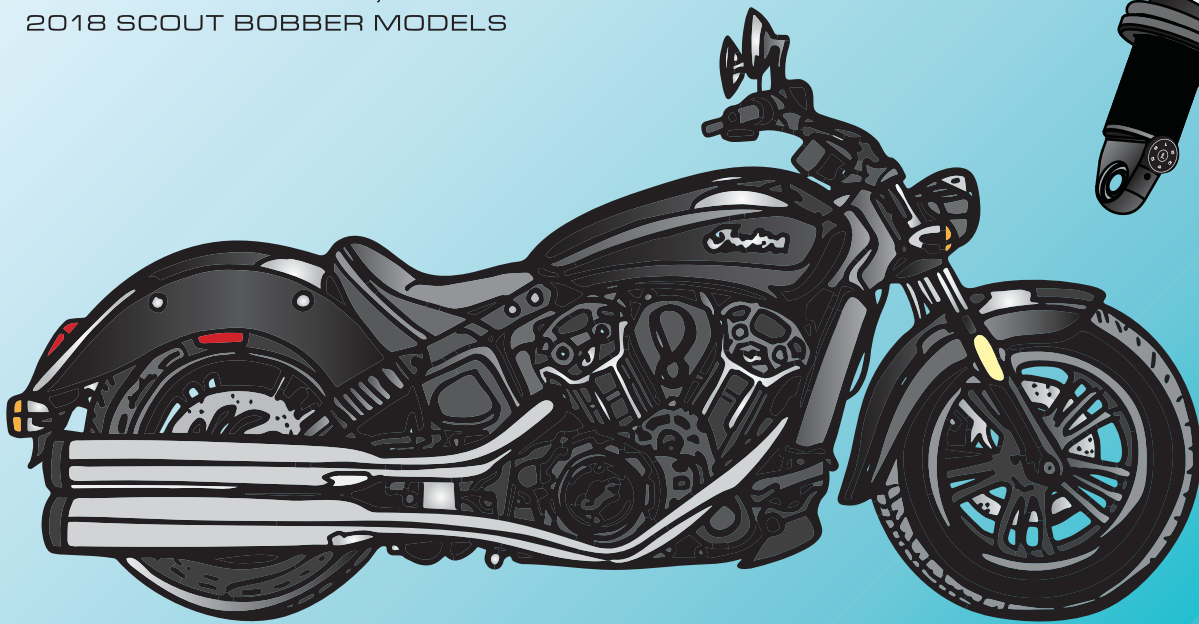

WARRANTY

All Legend Suspensions™ parts are guaranteed to the original purchaser to be free of manufacturing defects and workmanship. Merchandise that fails to conform to these conditions will be repaired or replaced at Legend Suspensions™ option if the parts are returned to us by the purchaser. Warranty coverage is limited lifetime.

In the event warranty service is required, the original purchaser must call or e-mail Legend Suspensions™ immediately with the problem. Some problems can be rectified by a telephone call and need no further course of action.

A part that is suspect of being defective must not be replaced by a Dealer without prior authorization from Legend Suspensions™. If it is deemed necessary for Legend Suspensions™ to make an evaluation to determine whether the part was defective, a return authorization number must be obtained from Legend Suspensions™. The parts must be packaged properly so as to not cause further damage and be returned prepaid to Legend Suspensions™ with a copy of the original invoice of purchase. If after an evaluation has been made by Legend Suspensions™ and the part was found to be defective, repair will be made at Legend Suspensions™ discretion.

ADDITIONAL WARRANTY PROVISIONS

- (1) Legend Suspensions™ shall have no obligation in the event a Legend Suspension™ part is modified by any other person or organization.
- (2) Legend Suspensions™ shall have no obligation if a Legend Suspensions™ part becomes defective in whole or in part as a result of improper installation, improper maintenance, improper use, abnormal operation, or any other misuse or mistreatment of the part.
- (3) Legend Suspensions™ shall not be liable for any consequential or incidental damages resulting from the failure of a Legend Suspensions™ part, the breach of any warranties, the failure to deliver, delay in delivery in non-conforming condition, or for any other breach of contract of duty between Legend Suspensions™ and a customer.
- (4) Legend Suspensions™ shall have no warranty or liability obligation if a Legend Suspension™ part is used in any other application. Vehicles used in competition or off road are exempt from all warranties.
- (5) All warranty items will require the original purchase invoice.
- (6) Legend Suspensions™ shall have no warranty or liability obligation to cover workshop labor charges incurred to install or remove suspension system or individual components.
- (7) Electrical components have a one year manufacturers warranty from the original invoice date or installation.
- (8) Limited lifetime warranty is further defined as the lifetime of specific product line.
- (9) Customer is liable for shipping charges to and from Legend Suspensions™ for warranty repairs or replacement parts.

WARNING: Legend Suspensions™ assumes no responsibility for damage or injuries which may result from the use or installation of its products, whether or not properly installed or used. Installing a Legend Suspensions system may decrease initial ground clearance when in lowered position. The motorcycle will be lower to the ground and care should be taken to avoid bottoming out, especially over bumps or in turns. To maintain proper balanced geometry, we recommend riding in the stock height position.

All parts sold or manufactured by Legend Suspensions™ are warranted against all manufacture defects or workmanship defects. Should a product we manufacture be defective, it must be returned to Legend Suspensions™. All returns must be authorized in advance with RA#. Freight must be prepaid by customer. If our product is found to be defective, it will be repaired free of charge or exchanged at Legend Suspensions™ discretion. Repairs or exchanges will not be issued if merchandise has been damaged, abused or modified. Any disagreement which may arise out of this agreement shall be submitted to arbitration and shall be enforceable under the laws of the State of South Dakota. Judgment on the award shall be entered into by the said court, and the decision of the arbitrator shall be a condition precedent to legal rights. The parties shall submit disputed matters under the Rules of the American Arbitration Association and the losing party shall pay both parties' attorneys' fees and costs.



For customer service e-mail service@legendsuspensions.com

WARNING



PROPERLY SUPPORT YOUR MOTORCYCLE PRIOR TO SUSPENSION INSTALLATION!

1

FIGURE A (LEFT SHOCK)

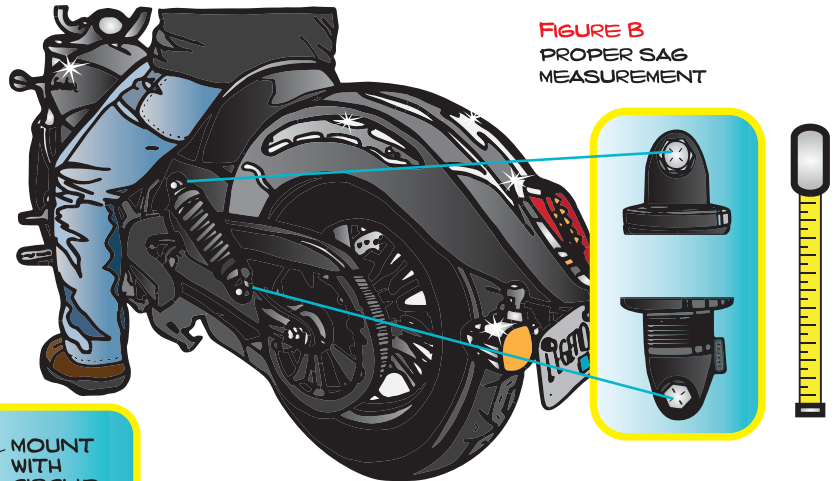
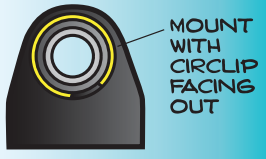
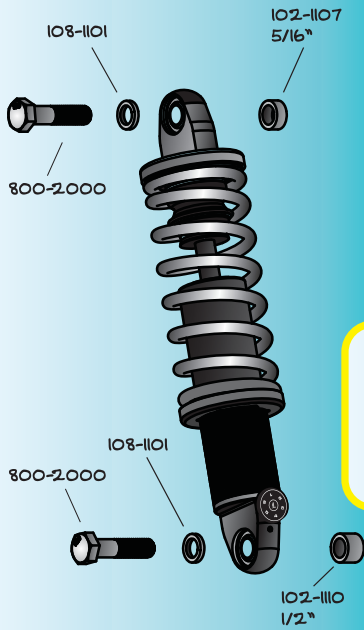

FIGURE B
PROPER SAG
MEASUREMENT

2

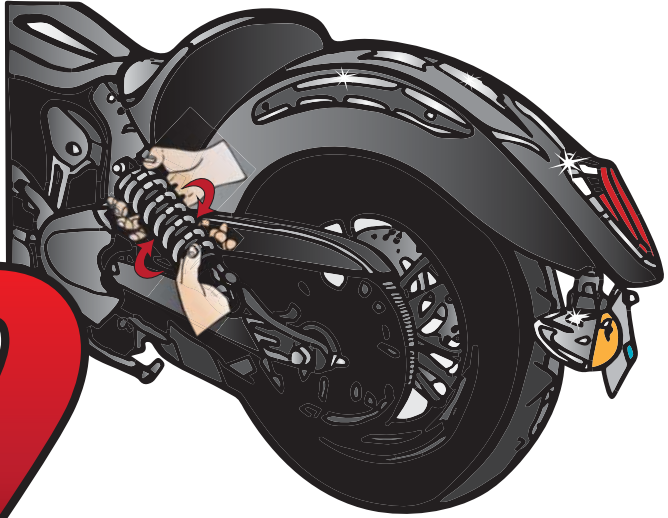

FIGURE C
ADJUST SAG EQUALLY ON BOTH SIDES



WARNING:

BEFORE PURCHASING OR ATTEMPTING TO INSTALL SHOCKS THAT ARE DIFFERENT THAN THE OEM LENGTH CONFIRM THAT YOUR WHEEL TRAVEL CAN BE ALTERED WITHOUT CAUSING CLEARANCE ISSUES SUCH AS, SWING ARM / AXLE TO EXHAUST CONTACT AS WELL AS CHAIN/BELT GUARD OR TIRE CONTACT.

STEP ONE: INSTALL SHOCKS

- A. WITH MOTORCYCLE PROPERLY SUPPORTED ON JACK, REMOVE THE STOCK SHOCKS.
- B. APPLY BLUE THREAD LOCKER TO THE FASTENERS AND INSTALL YOUR REVO SHOCKS/ SPACERS AS SHOWN IN FIGURE A. MOUNT WITH CIRCLIP FACING OUT, AND SILVER LABEL FACING IN.

STEP TWO: SET SAG

- A. SIT RIDER ON THE BIKE (WITH RIDING GEAR ON & OR LOAD OR PASSENGER YOU INTEND ON CARRYING). MEASURE FROM CENTER TO CENTER ON THE MOUNTING BOLTS. (FIGURE B)

SHOCK LENGTH:	PROPER SAG MEASUREMENT
11 9/16"	11 1/8"

- B. TO ADJUST SAG, REMOVE RIDER(S) FROM THE BIKE. TIGHTEN SPRING BY HAND FOR LESS SAG OR LOOSEN SPRING TO INCREASE SAG. ADJUST EACH SIDE EQUALLY. (FIGURE C)

FINE TUNE REBOUND DAMPING:
FOR LEGEND AIR-A AND REVO-A MODELS
MACHINED RECESS BELOW REBOUND ADJUSTER INDICATES REBOUND SETTING.

- SETTING 1: PROVIDES LOWEST LEVEL OF REBOUND DAMPING. ALSO SOFTENS SHOCK SLIGHTLY DURING COMPRESSION.
- SETTING 3: PROVIDES INTERMEDIATE LEVEL OF REBOUND DAMPING.
IMPORTANT: MOST COMMONLY USED SETTING
- SETTING 6: PROVIDES HIGHEST LEVEL OF REBOUND DAMPING. ALSO STIFFENS SHOCK SLIGHTLY DURING COMPRESSION.

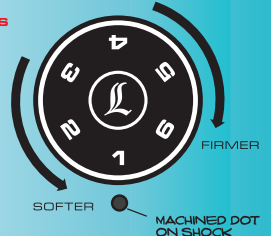

3

STEP THREE: REBOUND DAMPING

- A. REBOUND DAMPING CONTROLS THE SPEED AT WHICH THE SHOCK ABSORBER EXTENDS AFTER BEING COMPRESSED. **USE SETTING 3.** GO TEST RIDE. STOP, ADJUST BOTH SIDES + OR - ONE INCREMENT. RUN THE SAME ROUTE AGAIN. REPEAT UNTIL PREFERRED SETTING IS FOUND. LOWER # SETTING FOR SOFTER, MORE COMPLIANT RIDE QUALITY; HIGHER # SETTING FOR MORE SPORT/PERFORMANCE FEEL.