

Congratulations, you have purchased the finest exhaust system available for your motorcycle. Your Vance & Hines exhaust is designed and crafted for performance, quality, and style. Please follow the instructions below, check exhaust system for missing or damaged parts and if you need any assistance please contact our technical support line (562) 921-7461.

FOR CLOSED COURSE COMPETITION USE ONLY. NOT INTENDED FOR STREET USE.

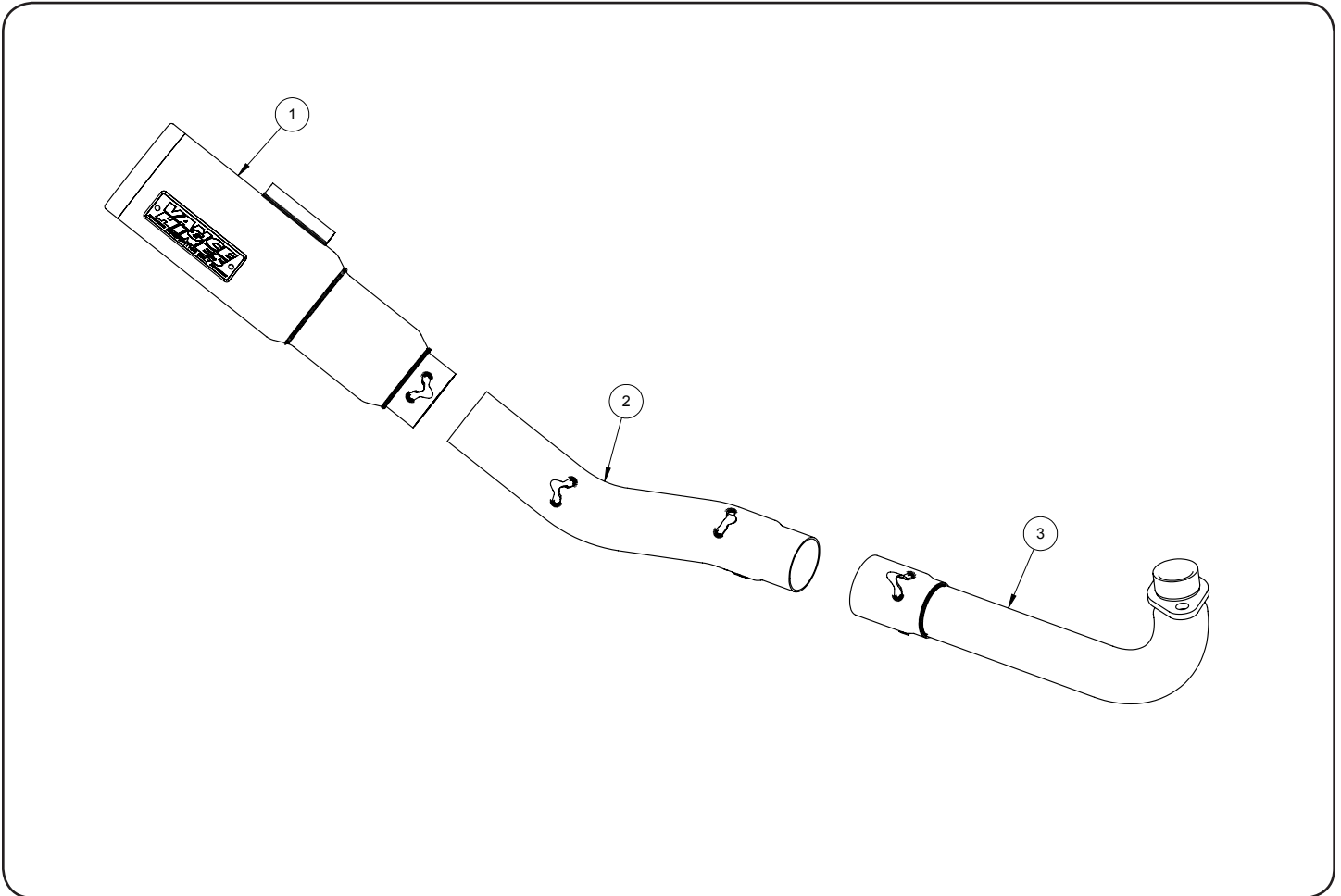

PARTS LIST

PART NO.	Description	Qty.	PART NO.	Description	Qty.
1	H675RB-S Muffler Assembly	1	7	A170HW Nut Hex M8 X 1.25	3
2	H674RB Mid-Pipe Assembly	1	8	A260SP Spring Puller	1
3	H173FB Header Assembly	1	9	A544HW M6X1X10 Screw	2
4	1175 Mount Bracket	1	10	A616HW M8 Flat Washer	1
5	A115SP Dirt Sport Spring	4	11	A712ST Mount Spacer	2
6	A452HW M8X1.25X40mm SHCS	1	12	A713ST M8 SHCS Cover	1

HARDWARE

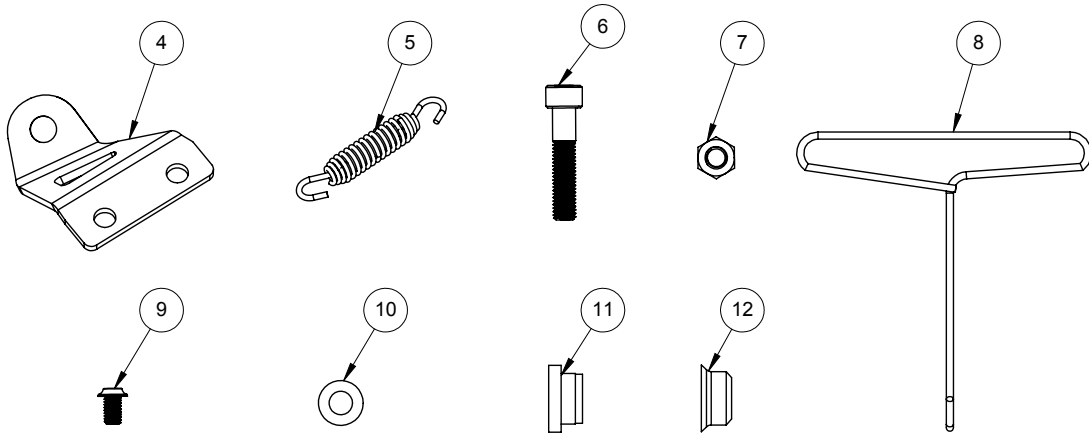

TOOLS REQUIRED



Wrenches: 12mm, 13 mm

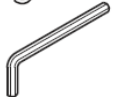

Allen Wrench: 4mm, 6mm

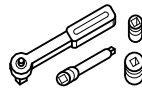

Sockets: 12mm

STOCK SYSTEM REMOVAL

1. Remove the two cylinder exhaust port nuts from head pipe, located at the cylinder head.
2. Remove the exhaust chassis mount bolt.
3. Remove the muffler mount bolt.
4. Remove the complete exhaust system and set aside (assistance may be required).
5. Remove the rubber grommet from stock muffler mount.
6. Check the condition of exhaust gaskets and replace if worn or damaged.

VANCE & HINES SYSTEM INSTALLATION

1. Install header using supplied M8 nuts (A170HW). Do not fully tighten at this time.
2. Slip midpipe (H674RB) onto header (H173FB). Align the spring clips.
3. Attach bracket (1175) to muffler (H675RB-S) with the two M6 screws (A544HW). Fully tighten bracket to muffler. Be sure to align mounting bracket with muffler tent bracket.
4. Slip muffler (H675RB-S) onto midpipe (H674RB).
5. Attach muffler with bracket (1175) to muffler mount (**Figure 1**).
 - a. Insert bracket spacers (A712ST) in-between the bracket and muffler mount.
 - b. Insert M8 socket head screw (A452HW) into M8 socket head cover (A713ST).
 - c. Install muffler assembly using washer (A616HW) and one M8 nut (A170HW).
 - d. Do not fully tighten at this time.
6. Tighten cylinder exhaust port nuts evenly.
7. Tighten muffler mounting screw.
8. Attach exhaust springs (A115SP) using supplied spring puller.

VANCE & HINES SYSTEM INSTALLATION

1. When installing new stainless steel make sure your hands are clean and free of oil. After installation, thoroughly clean pipes and mufflers with a soft cloth and cleaning solvent that will leave no residue (acetone, glass cleaner, alcohol, etc...) before starting the motorcycle.
2. It is considered normal for stainless steel exhaust systems to discolor due to heat.
3. High performance engine tuning utilizing a dyno will likely result in severe discoloration.
4. Avoid long periods of idling as this can cause discoloration. Intake leaks can cause the engine to run lean and overheat, this could lead to discoloration.

FIGURE 1

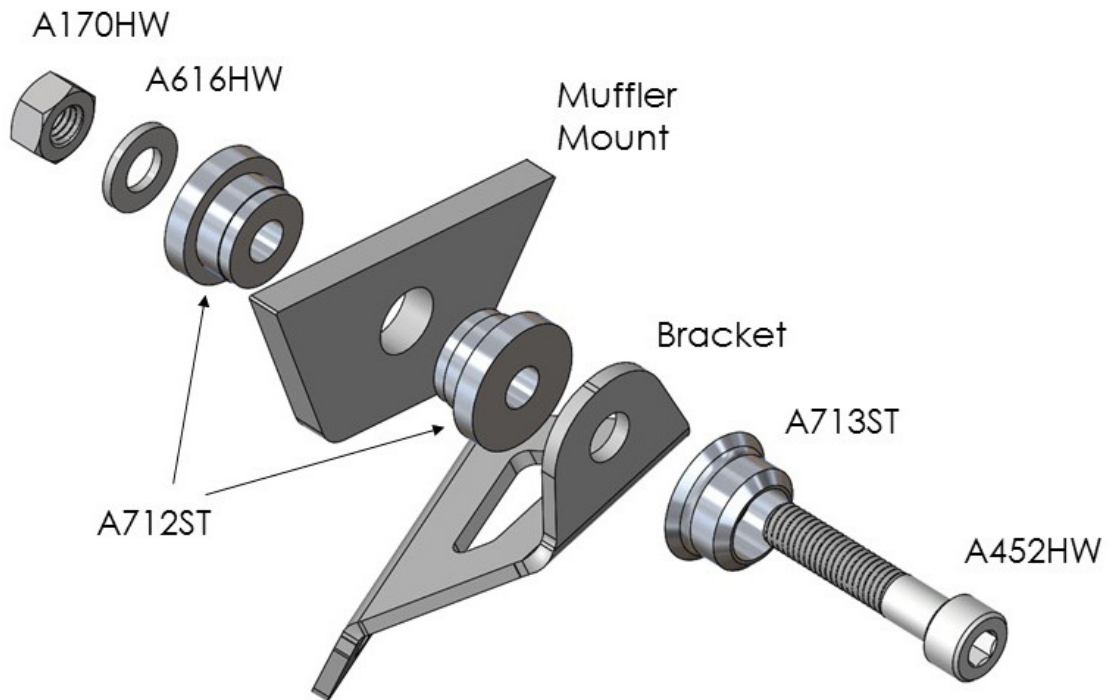

Emissions Notice:

In California, in order to meet Air Resources Board emissions requirements, certain aftermarket part applications have been identified as replacements, and others have received ARB Executive Orders. All other emissions related aftermarket parts are for competition use only. A list of replacement parts and EO parts, and corresponding fitment is provided at vanceandhines.com/California.

Warranty:

All Vance & Hines products are warranted against defects in material and workmanship for a period of 90 days. This warranty does not cover discoloration or rust. This warranty shall be limited to the repair or replacement of the product, which may be proven defective under normal use. Vance & Hines will not warranty any system that has been abused, misused, improperly installed or modified.

Dealers or distributors are not authorized to make dispositions binding upon Vance & Hines. Vance & Hines will not be responsible for any labor charges incurred in removing or replacing any system under warranty. A return authorization number and a copy of the original purchase invoice must accompany all returns. Parts returned without a return authorization may be refused.

13861 ROSECRANS AVENUE / SANTA FE SPRINGS, CA 90670
SALES: (562) 921-5388
TECHNICAL: (562) 926-5291
FAX: (562) 802-0110

vanceandhines
.com